

Data Sheet



Article number: 20166368

Description: E+G Cabinet U-handle GN 426-AL-28-300-SW

Measures

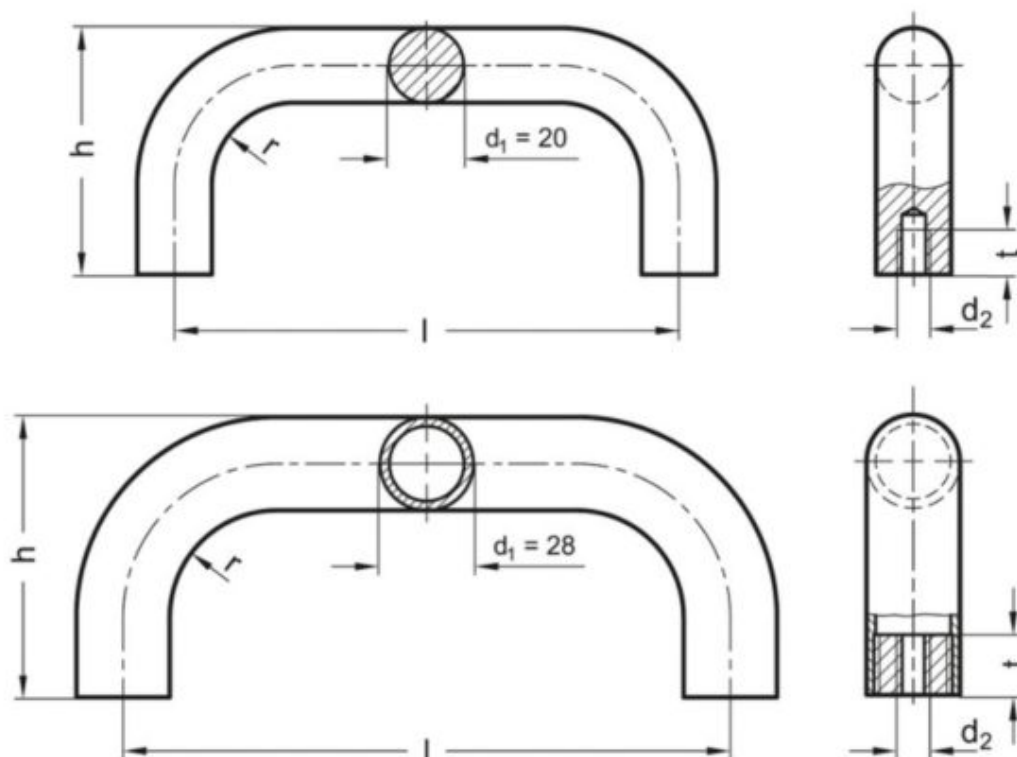

d_1	= 28
d_2	= M10
h	= 78
l	= 300
r	= 32
t_{min}	= 15